

Top Studio 2006 RC211V

1/12 Super Detail-Up Set

Detail Master www.topstudiohobby.com

制作前先将TAMIYA原件修整到图中状态
Please modify the Tamiya's original parts as the figures shown
⚠ 注意这些零件与车辆的配合! Pay attention to the fitting of small parts and cowling

↔ : 选择使用。Use either one

Wire number 配线编号: 1

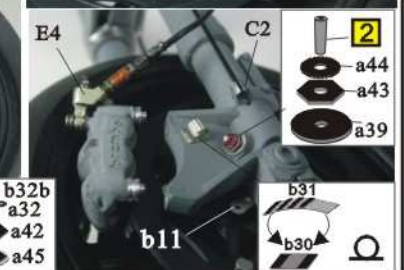
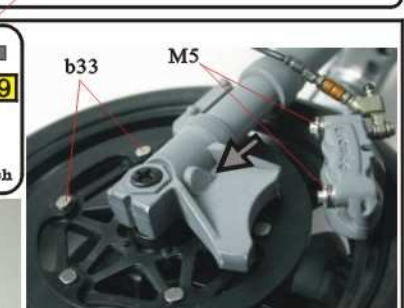
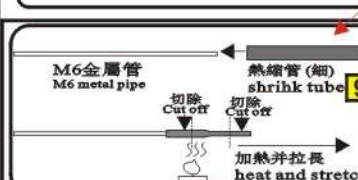
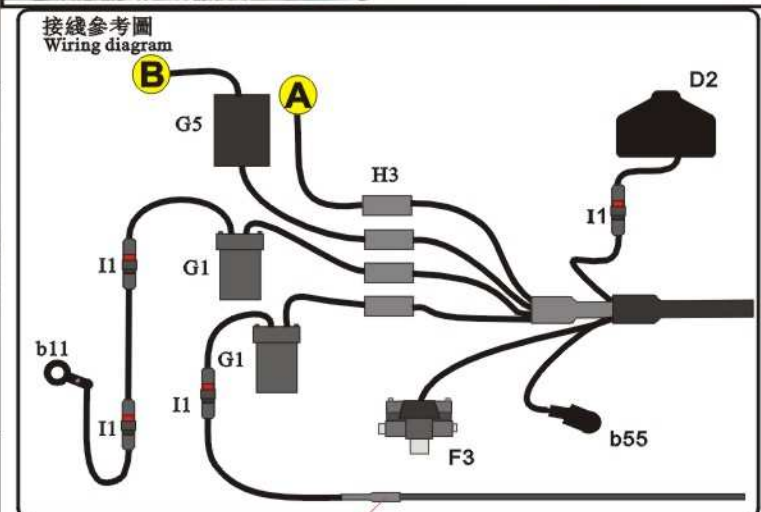
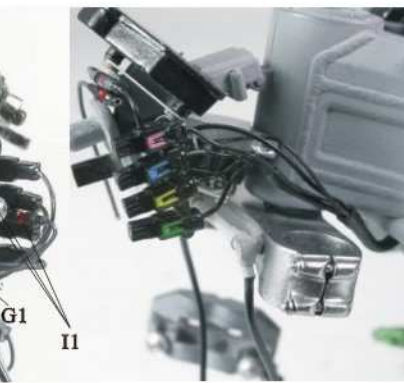
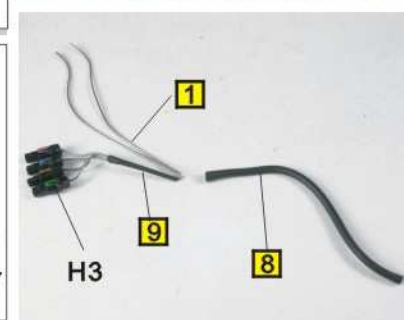
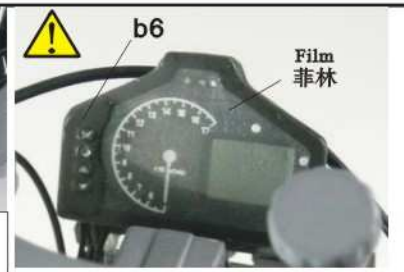
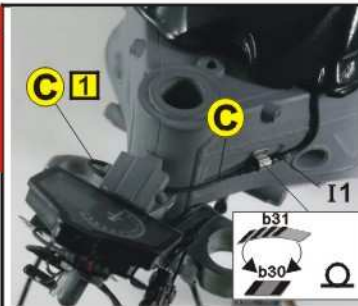
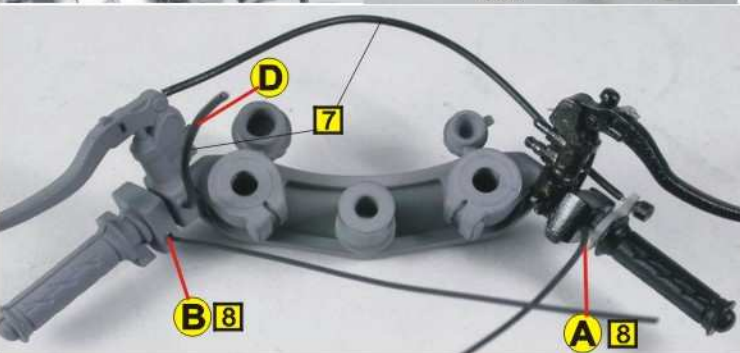
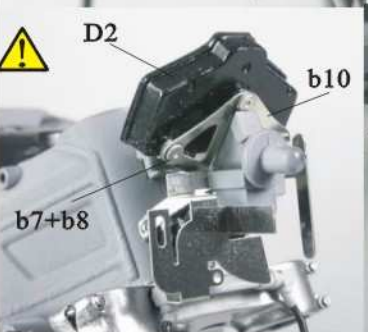
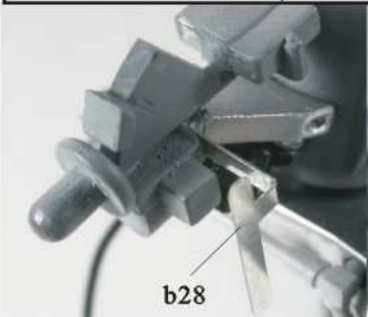
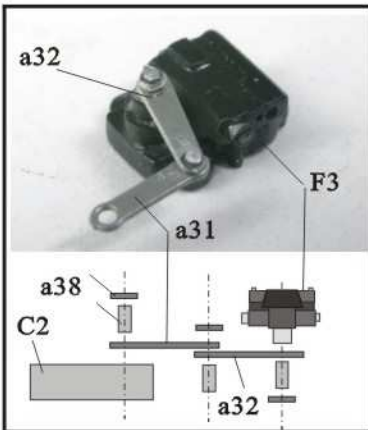
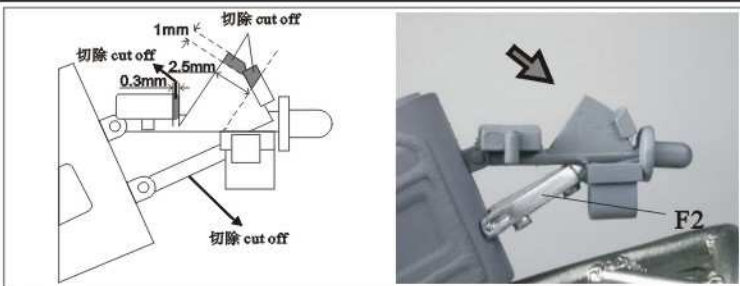

TAMIYA 管綫
Tamiya's vinyl tube

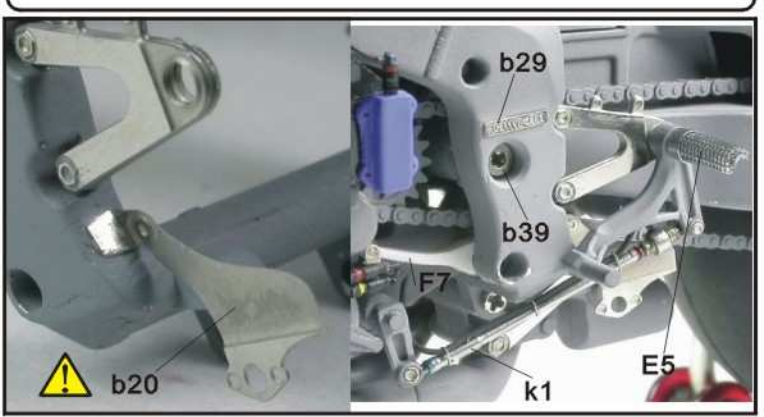
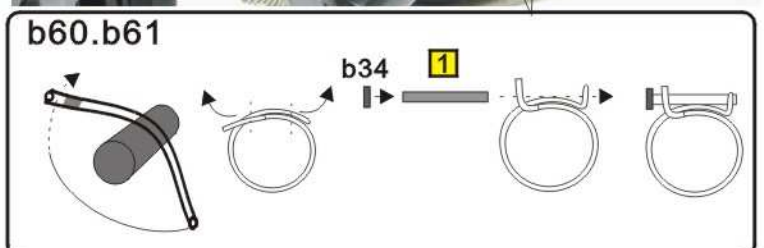
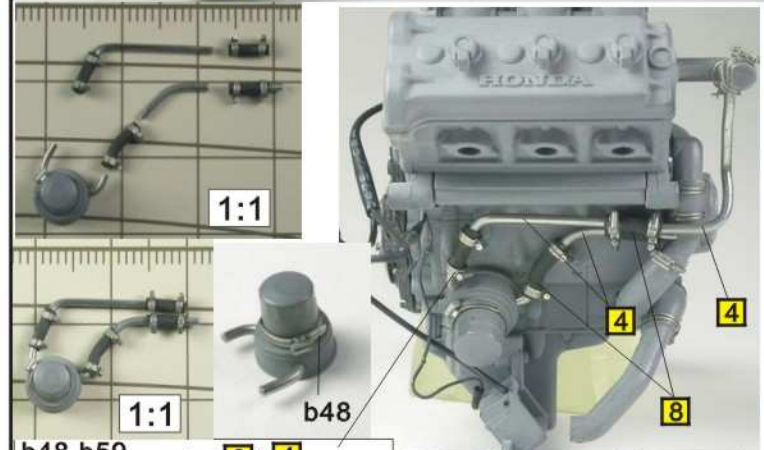
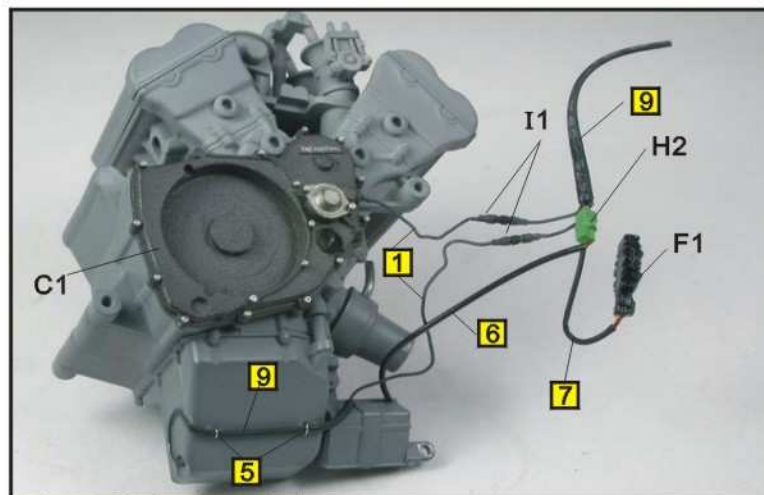
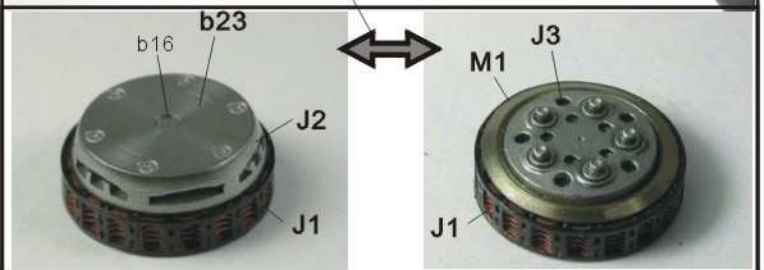

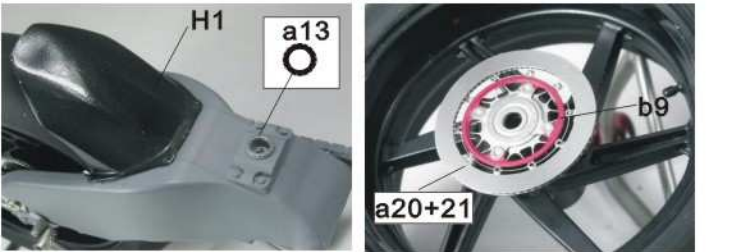
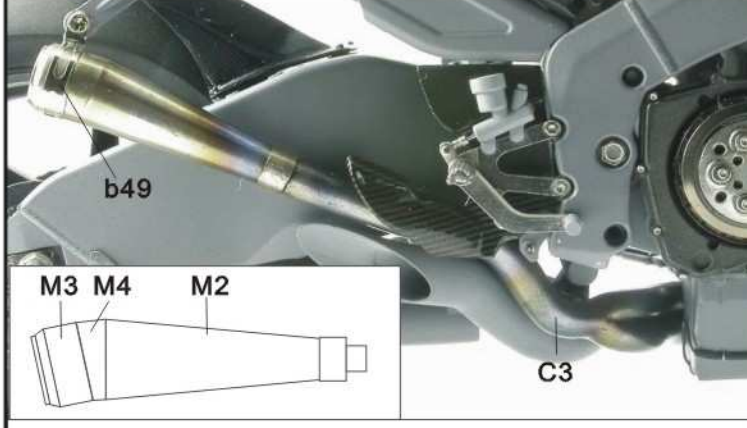
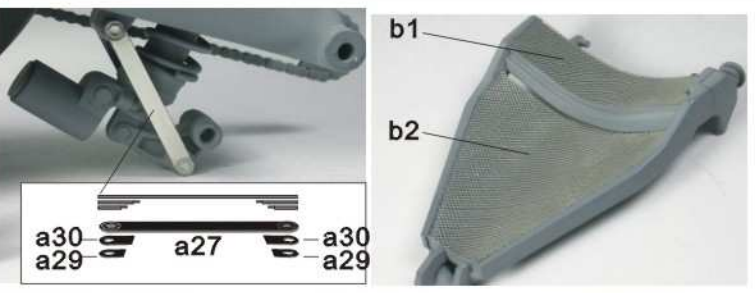
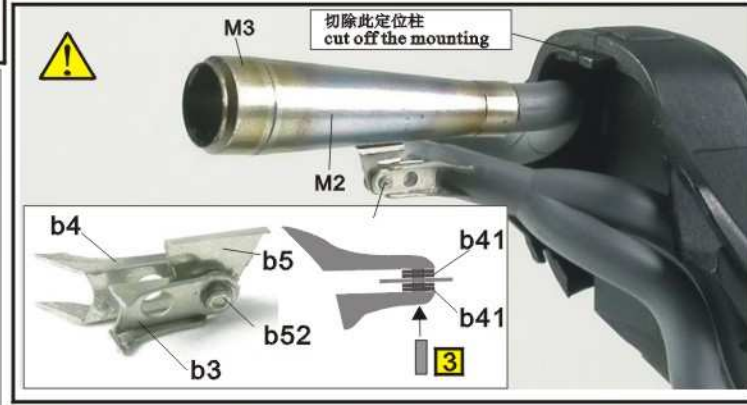
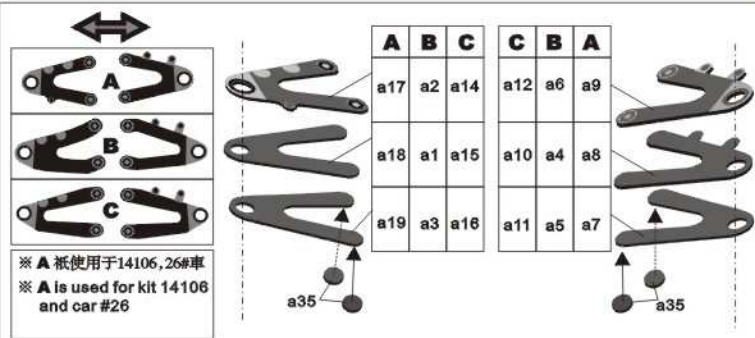
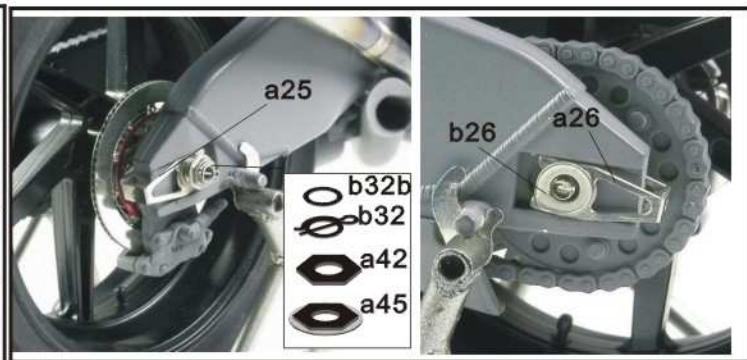
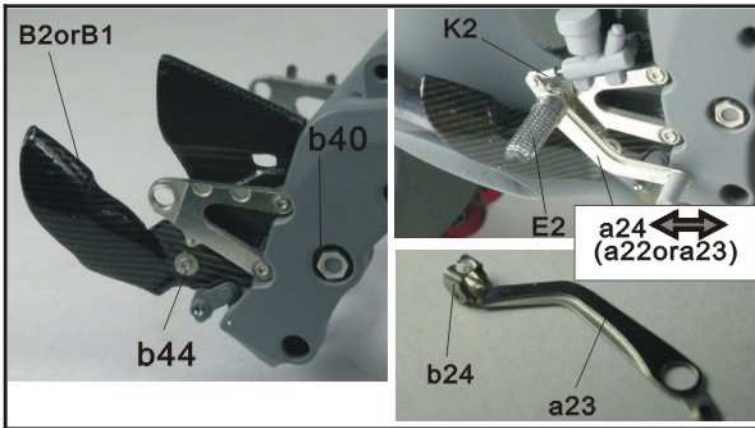

排氣管粘接後結合使用2000#沙紙打磨拋光，上色前必需用金屬底漆
 Sand the exhaust surface with #2000 sandpaper after adhering the exhaust parts.
 Apply metal primer before painting.

'04, '05 年使用: 車頭設備支架。
 The mounting part is used for the year 2004 or 2005.

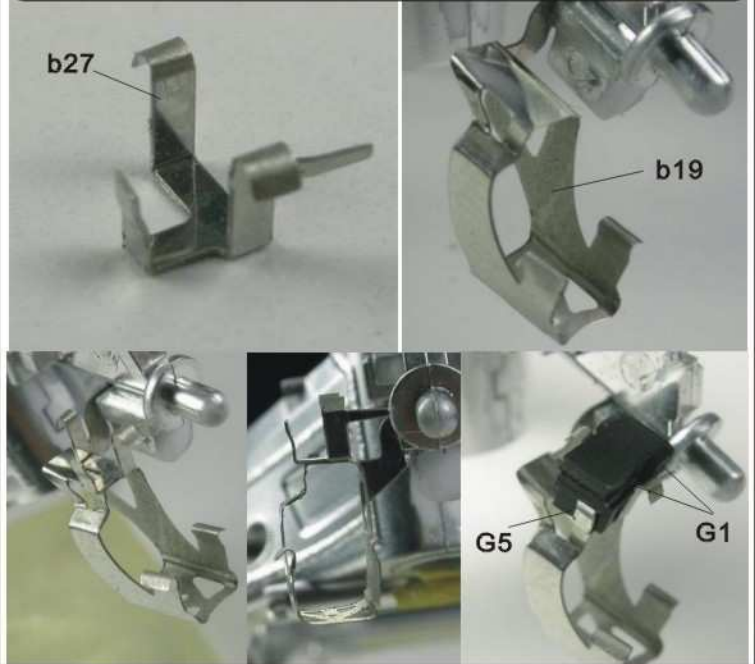

熱縮管使用:
 Using the shrink tube:

- 將熱縮管均勻加熱，加熱後，熱縮管收縮（此時為收縮的最大直徑）
 1. heat the shrink tube evenly, it will be shrunk (the tube now in the largest diameter)

加熱 Heat

- 待1-2秒後，將熱縮管拉長，可得到更小的綫徑，拉伸越長，綫徑越小。
 2. after 1-2 seconds, stretch the tube, it will be smaller in diameter when stretch more







拉長 stretch

熱縮管 Shrink tube	加工範圍 Size
黑色管(細) Black (thin)	1.0mm~0.4mm
黑色管(粗) Black (thick)	1.3mm~0.5mm

配線wire:

編號 number	規格 specification	數量 Quantity
1	0.3mm 錫線 0.3mm solder line	× 1
2	0.5mm 錫線 0.5mm solder line	× 1
3	0.6mm 錫線 0.6mm solder line	× 1
4	1.0mm 錫線 1.0mm solder line	× 1
5	細金屬線 thin metal wire	× 1
6	0.5mm 黑色電線 0.5mm black wire	× 1
7	0.6mm 黑色電線 0.6mm black wire	× 1
8	黑色熱縮管(粗) Black shrink tube()	× 3
9	黑色熱縮管(細) Black shrink tube()	× 3

金屬部件
Metal Parts

M1		× 1
M2		× 2
M3		× 2
M4		× 1
M5		× 4
M6		× 1

樹脂部件
Resin Parts

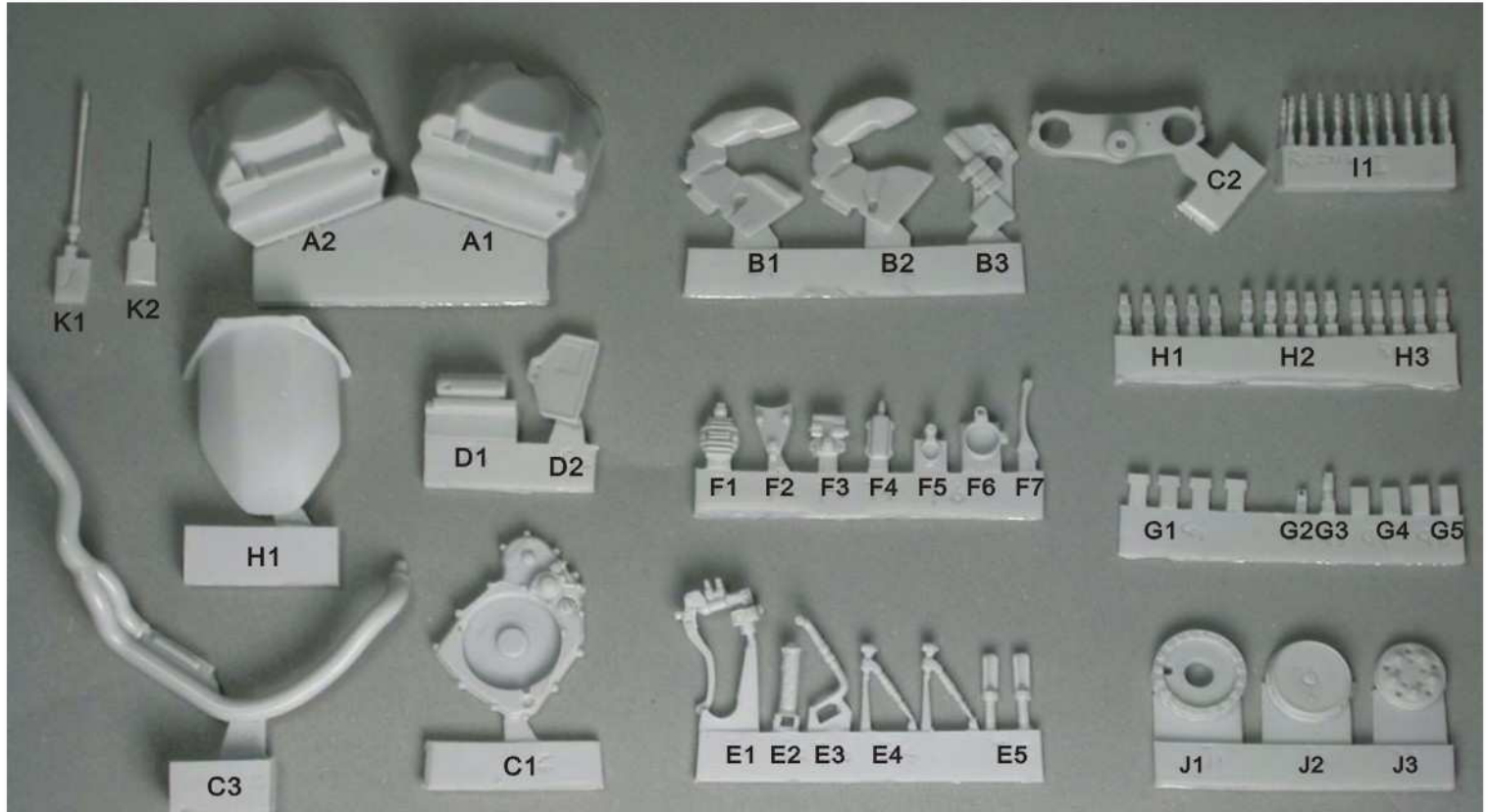

※ A2, B2 祇使用于14106, 26#車
 ※ A2, B2 are used for kit 14106 and car #26

其它配件:

Other materials



菲林 × 1,

鉛箔貼紙 (用于制作隔熱層) × 2,
 metal foil sticker (using as heat shield)

蝕刻片A × 1 Photo-etched plate A × 1

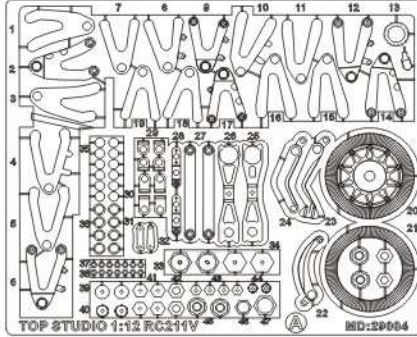

蝕刻片B × 1 Photo-etched plate B × 1

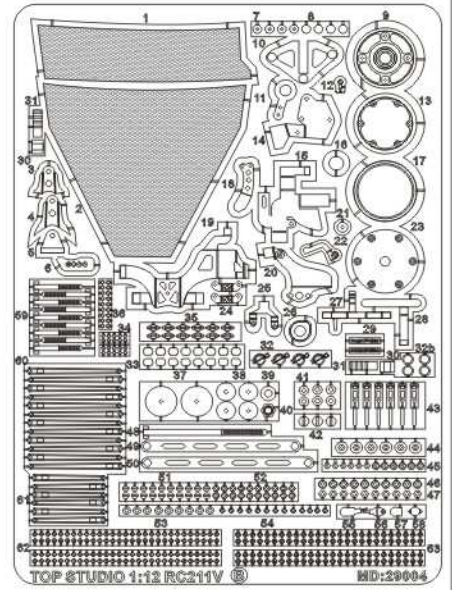

請在以下網址下載更多高解像圖片及彩色說明書:

Please download more high-resolution pictures and instruction sheets with color from below links:

<http://www.topstudiohobby.com/product/MD29004/MD29004.rar>

http://www.topstudiohobby.com/instruction/MD29004_instruction.rar

※ 腳架是 TD23008 產品, 不包括在套件裡

[Please note that the racing stand is Top Studio's item TD2308 which is not included in this set.